



US00D855802S

(12) **United States Design Patent** (10) **Patent No.:** **US D855,802 S**
Marcoux et al. (45) **Date of Patent:** **** Aug. 6, 2019**

(54) **DISPOSABLE TOOL**

FOREIGN PATENT DOCUMENTS

(71) Applicant: **Interscope, Inc.**, Whitinsville, MA (US)

DE 33 39 322 A1 5/1984
DE 33 20 076 A1 12/1984

(72) Inventors: **Michael Walter Marcoux**, Jamaica Plain, MA (US); **Kristen Dodds Weight**, Stow, MA (US); **Sarah Kostanski**, Chelmsford, MA (US); **Jeffery Bennith Ryan, Jr.**, Whitinsville, MA (US)

(Continued)

OTHER PUBLICATIONS

Canadian Examination Report on CA Application No. 2911545 dated Nov. 20, 2015.

(Continued)

(73) Assignee: **Interscope, Inc.**, Whitinsville, MA (US)

Primary Examiner — Eliza Z Bennett-Hattan

(**) Term: **15 Years**

(74) *Attorney, Agent, or Firm* — Foley & Lardner LLP

(21) Appl. No.: **29/545,290**

(57) **CLAIM**

We claim the ornamental design for a disposable tool, as shown and described.

(22) Filed: **Nov. 11, 2015**

DESCRIPTION

Related U.S. Application Data

(63) Continuation-in-part of application No. 14/501,957, filed on Sep. 30, 2014, now Pat. No. 9,204,868, which
(Continued)

(51) **LOC (12) Cl.** **24-02**

(52) **U.S. Cl.**
USPC **D24/138**

(58) **Field of Classification Search**
USPC D24/108, 113, 127, 138, 137, 133, 147,
D24/144

(Continued)

(56) **References Cited**

U.S. PATENT DOCUMENTS

3,760,810 A 9/1973 Van Hoorn
3,834,392 A 9/1974 Lampman et al.

(Continued)

FIG. 1 is a bottom, front, left perspective view of the claimed design;

FIG. 2 is a top, rear, right perspective view thereof;

FIG. 3 is a front elevation view thereof;

FIG. 4 is a rear elevation view thereof;

FIG. 5 is a top plan view thereof;

FIG. 6 is a bottom plan view thereof;

FIG. 7 is a left elevation view thereof; and,

FIG. 8 is a right elevation view thereof.

The ornamental design which is claimed is shown in solid lines in the drawings.

The broken lines in the drawings form no part of the claimed design. Broken lines formed by equal length dashes show unclaimed subject matter. Broken lines formed of unequal length dashes (i.e., dash-dot) define bounds of the claimed design.

The disposable tool is shown with a symbolic break in its length. The appearance of any portion of the article between the break lines forms no part of the claimed design.

The unshaded areas form no part of the claim.

1 Claim, 6 Drawing Sheets

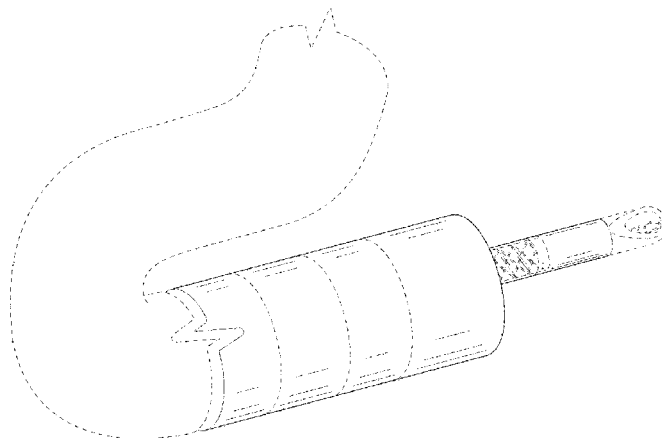

Related U.S. Application Data

is a continuation-in-part of application No. 14/280, 202, filed on May 16, 2014, now Pat. No. 8,882,680, which is a continuation-in-part of application No. 13/336,491, filed on Dec. 23, 2011, now Pat. No. 9,808,146.

(58) **Field of Classification Search**

CPC A61B 1/005
See application file for complete search history.

(56)

References Cited

U.S. PATENT DOCUMENTS

3,911,923 A 10/1975 Yoon
4,222,380 A 9/1980 Terayama
4,226,239 A 10/1980 Polk et al.
4,257,419 A 3/1981 Goltner et al.
4,548,201 A 10/1985 Yoon
4,646,738 A 3/1987 Trott
4,756,309 A 7/1988 Sachse et al.
4,763,667 A 8/1988 Manzo
4,834,729 A 5/1989 Sjostrom
4,950,278 A 8/1990 Sachse et al.
4,966,162 A 10/1990 Wang
5,259,366 A * 11/1993 Reydel A61B 1/00135
383/203
5,269,789 A 12/1993 Chin et al.
5,320,630 A 6/1994 Ahmed
5,320,635 A 6/1994 Smith
5,349,940 A 9/1994 Takahashi et al.
5,417,697 A 5/1995 Wilk et al.
5,423,834 A 6/1995 Ahmed
5,462,559 A 10/1995 Ahmed
5,507,797 A 4/1996 Suzuki et al.
5,529,580 A 6/1996 Kusunoki et al.
5,662,671 A 9/1997 Barbut et al.
5,871,453 A 2/1999 Banik et al.
5,961,534 A 10/1999 Banik et al.
6,010,515 A * 1/2000 Swain A61B 1/00089
600/104
6,059,719 A 5/2000 Yamamoto et al.
6,068,603 A 5/2000 Suzuki
6,193,672 B1 2/2001 Clement
6,245,011 B1 6/2001 Dudda et al.
6,517,560 B1 2/2003 Toth et al.
6,572,578 B1 6/2003 Blanchard
6,585,694 B1 7/2003 Smith et al.
6,645,218 B1 11/2003 Cassidy et al.
6,666,854 B1 12/2003 Lange
6,689,146 B1 2/2004 Himes
6,740,030 B2 * 5/2004 Martone A61B 1/00071
600/104
7,247,161 B2 7/2007 Johnston et al.
7,276,074 B2 10/2007 Adams et al.
7,625,347 B2 12/2009 Burbank et al.
7,691,110 B2 4/2010 Secrest et al.
7,857,784 B2 12/2010 Schmidberger et al.
8,070,756 B2 12/2011 Secrest et al.
8,070,762 B2 12/2011 Escudero et al.
8,123,750 B2 2/2012 Norton et al.
8,277,474 B2 10/2012 Norman et al.
8,343,047 B2 * 1/2013 Albrecht A61B 1/32
600/206
8,435,259 B2 5/2013 Dierck
8,475,484 B2 7/2013 Wulfman et al.
8,480,689 B2 * 7/2013 Spivey A61B 17/06066
606/144
8,506,564 B2 * 8/2013 Long A61B 18/1477
606/41
8,528,563 B2 9/2013 Gruber
8,574,254 B2 11/2013 Hedstrom et al.
8,696,621 B2 4/2014 Gunday et al.
8,939,897 B2 * 1/2015 Nobis A61B 1/2736
600/127

9,005,220 B2 * 4/2015 Wallace A61B 17/0469
606/144
9,095,367 B2 8/2015 Olson et al.
2002/0013570 A1 1/2002 Ruegg et al.
2003/0055315 A1 3/2003 Gatto et al.
2004/0147934 A1 7/2004 Kiester
2004/0162572 A1 8/2004 Sauer
2005/0090848 A1 4/2005 Adams
2005/0159767 A1 7/2005 Adams et al.
2005/0272976 A1 12/2005 Tanaka et al.
2006/0064113 A1 * 3/2006 Nakao A61B 10/06
606/113
2007/0197871 A1 8/2007 Geitz et al.
2007/0203395 A1 * 8/2007 Mikkaichi A61B 1/00087
600/127
2008/0082021 A1 4/2008 Ichikawa et al.
2008/0183201 A1 7/2008 Berberich
2008/0194910 A1 8/2008 Miyamoto et al.
2008/0234602 A1 9/2008 Oostman et al.
2009/0069806 A1 3/2009 De La Mora Levy et al.
2009/0234378 A1 9/2009 Escudero et al.
2009/0240261 A1 9/2009 Drews et al.
2010/0010525 A1 1/2010 Lockard et al.
2010/0016757 A1 * 1/2010 Greenburg A61B 1/0125
600/562
2010/0036375 A1 2/2010 Regadas
2010/0048992 A1 2/2010 Okada et al.
2010/0081874 A1 4/2010 Miyamoto et al.
2010/0121141 A1 5/2010 Rontal
2010/0168512 A1 7/2010 Rahmani
2010/0217245 A1 8/2010 Prescott
2010/0298855 A1 11/2010 Dierck
2011/0257477 A1 * 10/2011 McWeeney A61B 1/00073
600/104
2011/0270126 A1 11/2011 Gunday et al.
2012/0109130 A1 5/2012 Casey et al.
2012/0226101 A1 9/2012 Tinkham et al.
2012/0226103 A1 9/2012 Gunday et al.
2013/0016316 A1 1/2013 Cheng et al.
2013/0046313 A1 2/2013 Sullivan et al.
2013/0046316 A1 2/2013 Sullivan et al.
2013/0103067 A1 4/2013 Fabro et al.
2013/0190561 A1 7/2013 Oskin et al.
2014/0100567 A1 4/2014 Edwards et al.
2014/0155923 A1 6/2014 Edwards et al.
2014/0236165 A1 8/2014 Ries et al.
2014/0249448 A1 * 9/2014 Furlong A61B 10/04
600/563

FOREIGN PATENT DOCUMENTS

DE 19522403 A1 9/1997
EP 0 609 084 A2 8/1994
EP 1 586 275 10/2005
EP 1 875 871 A2 9/2008
WO WO-95/30377 11/1995
WO WO-01/22889 4/2001
WO WO-2006/122279 11/2006
WO WO-2012/075409 A1 6/2012

OTHER PUBLICATIONS

International Preliminary Report on Patentability dated Nov. 26, 2015 in PCT Application No. PCT/US2014/038443.
International Preliminary Report on Patentability dated Jun. 12, 2014 in PCT Application No. PCT/US2012/067614.
International Search Report and Written Opinion dated May 28, 2013 in PCT App. No. PCT/US2012/067614.
International Search Report and Written Opinion for International Patent Application No. PCT/US2014/038443 dated Sep. 1, 2014.
International Search Report and Written Opinion of the International Searching Authority for International Application No. PCT/US2015/052977 dated Dec. 18, 2015.
International Search Report and Written Opinion of the International Searching Authority for International Application No. PCT/US2015/052979 dated Dec. 17, 2015.

(56)

References Cited

OTHER PUBLICATIONS

International Search Report and Written Opinion of the International Searching Authority on International Application No. PCT/US2015/052978 dated Dec. 17, 2015.

U.S. Notice of Allowance in U.S. Appl. No. 14/501,942 dated Mar. 18, 2015.

U.S. Notice of Allowance in U.S. Appl. No. 14/501,957 dated Oct. 21, 2015.

U.S. Notice of Allowance in U.S. Appl. No. 14/280,202 dated Oct. 7, 2014.

U.S. Notice of Allowance in U.S. Appl. No. 14/501,865 dated Feb. 20, 2015.

U.S. Notice of Allowance in U.S. Appl. No. 14/537,362 dated May 26, 2015.

U.S. Office Action for U.S. Appl. No. 14/501,957 dated Nov. 14, 2014 (INT-106US).

U.S. Office Action in U.S. Appl. No. 14/501,957 dated Mar. 19, 2015.

U.S. Office Action in U.S. Appl. No. 14/280,202 dated Aug. 20, 2014.

U.S. Office Action in U.S. Appl. No. 14/501,865 dated Dec. 4, 2014.

U.S. Office Action in U.S. Appl. No. 14/501,932 dated Nov. 26, 2014.

U.S. Office Action in U.S. Appl. No. 14/501,942 dated Dec. 15, 2014.

U.S. Office Action in U.S. Appl. No. 14/537,362 dated Feb. 11, 2015.

U.S. Office Action on U.S. Appl. No. 13/336,491 dated Sep. 18, 2015.

First Office Action issued on Feb. 3, 2016 in Chinese Patent Application No. 201280068003.8.

Office Action in European Patent Application No. 14731875.2 dated Feb. 12, 2016.

U.S. Office Action for U.S. Appl. No. 13/336,491 dated Mar. 2, 2016.

U.S. Office Action for U.S. Appl. No. 14/316,203 dated Mar. 15, 2016.

* cited by examiner

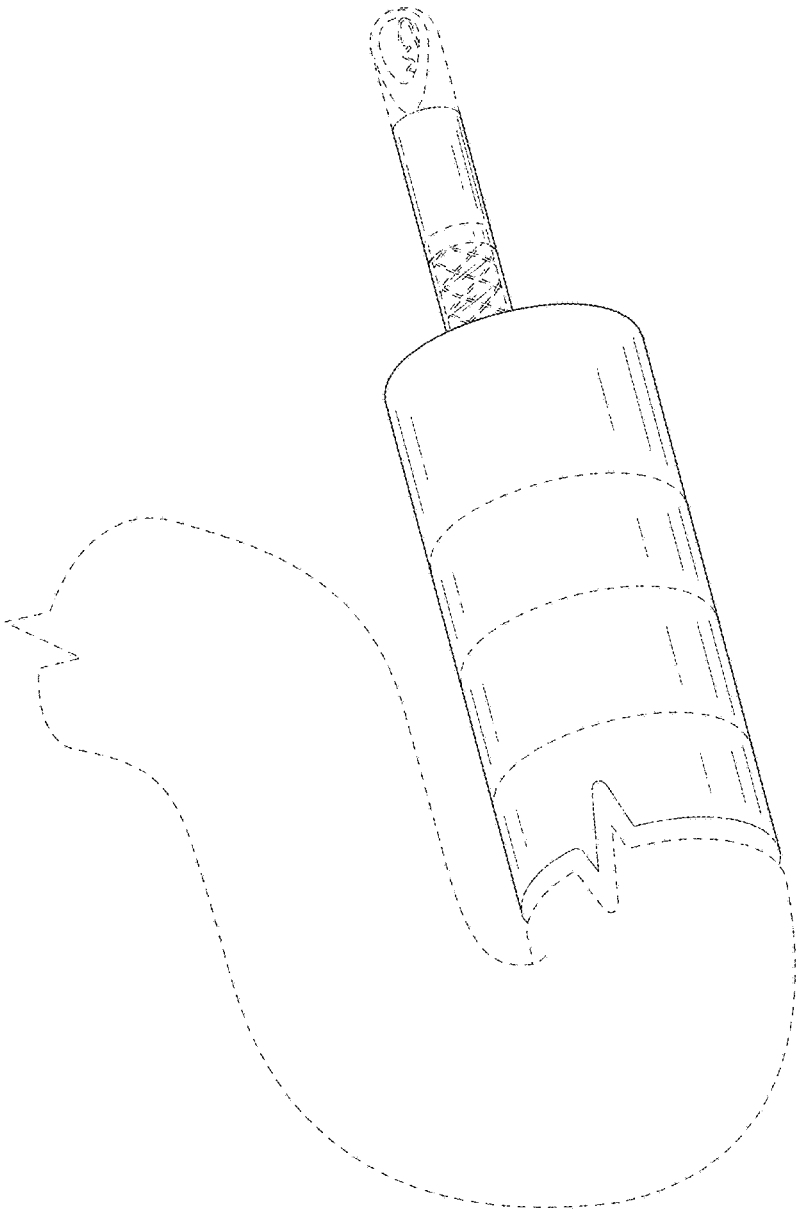

FIG. 1

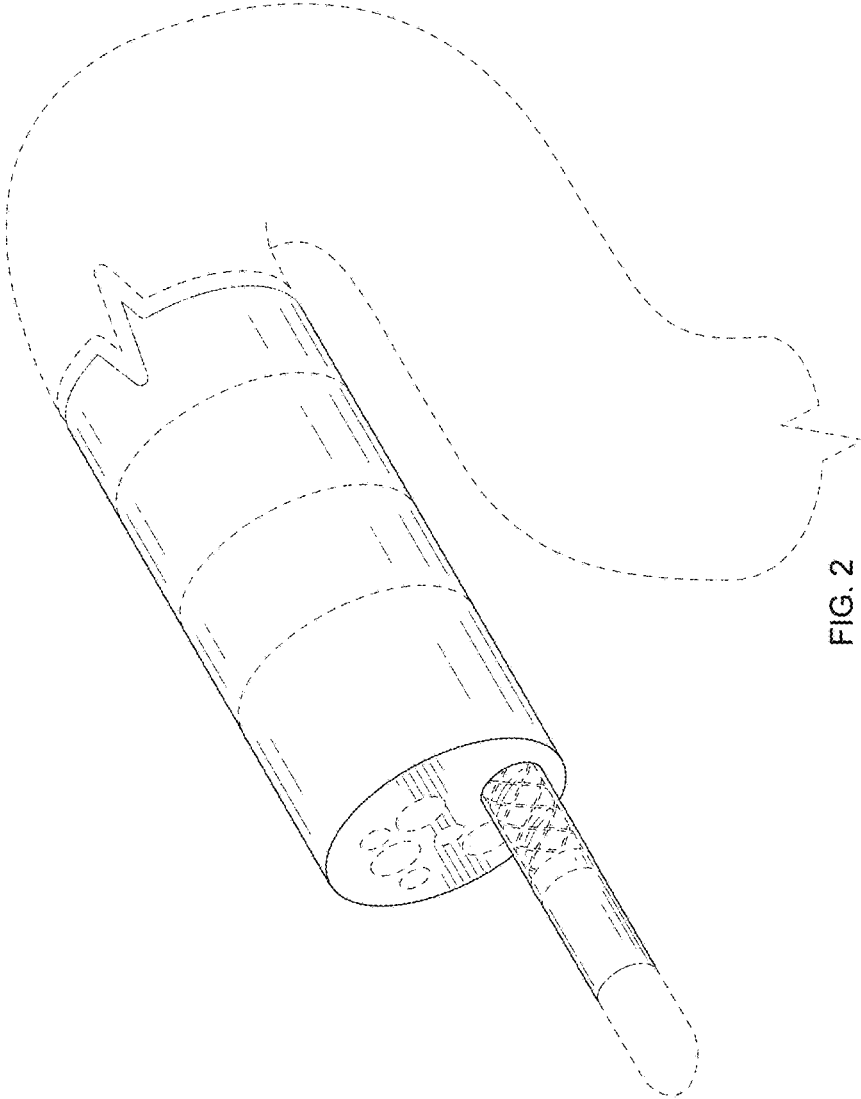

FIG. 2

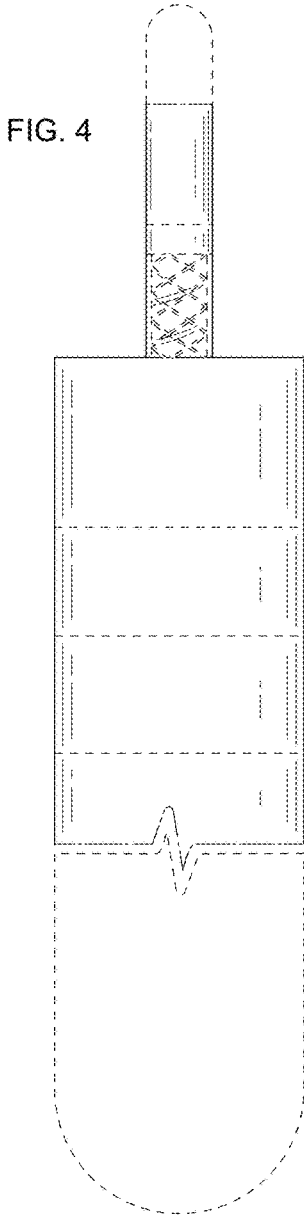
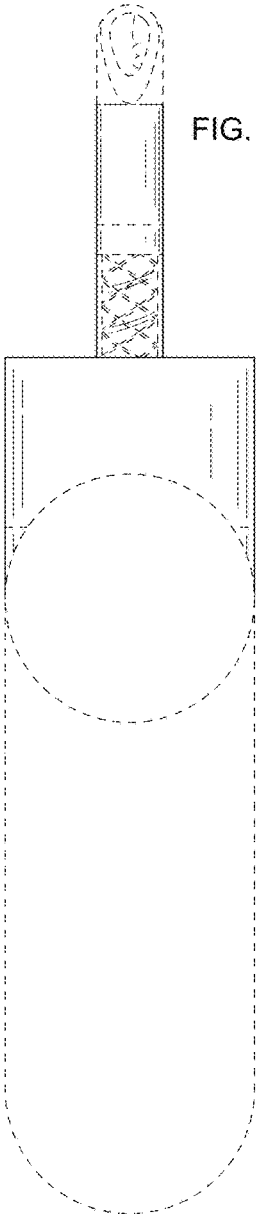

FIG. 5

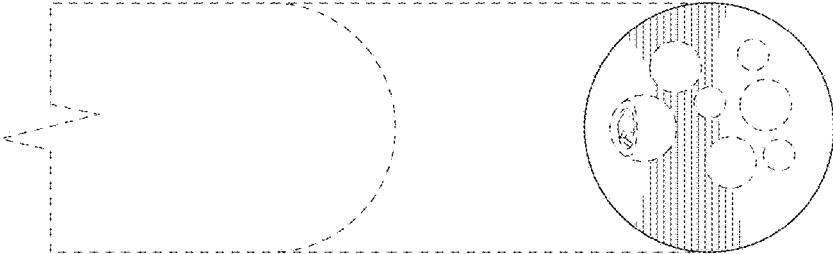

FIG. 6



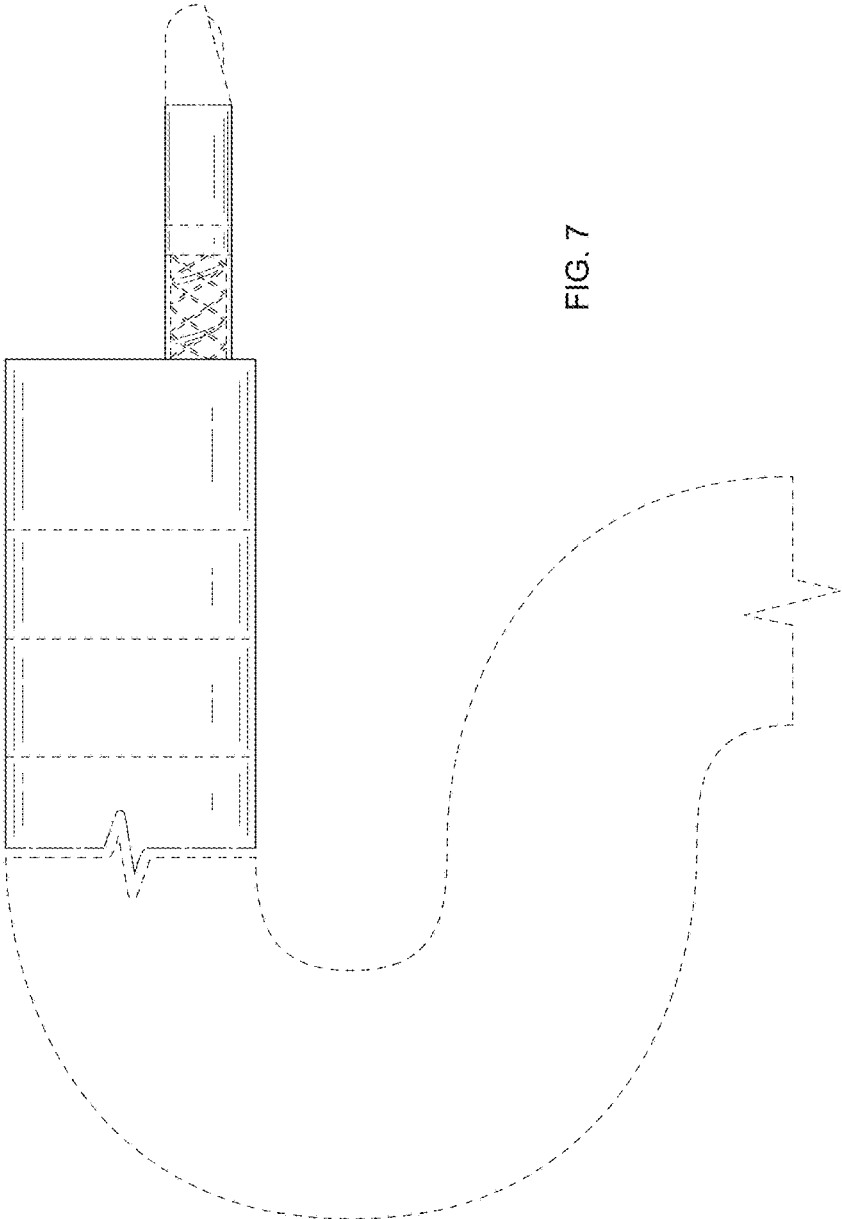

FIG. 7

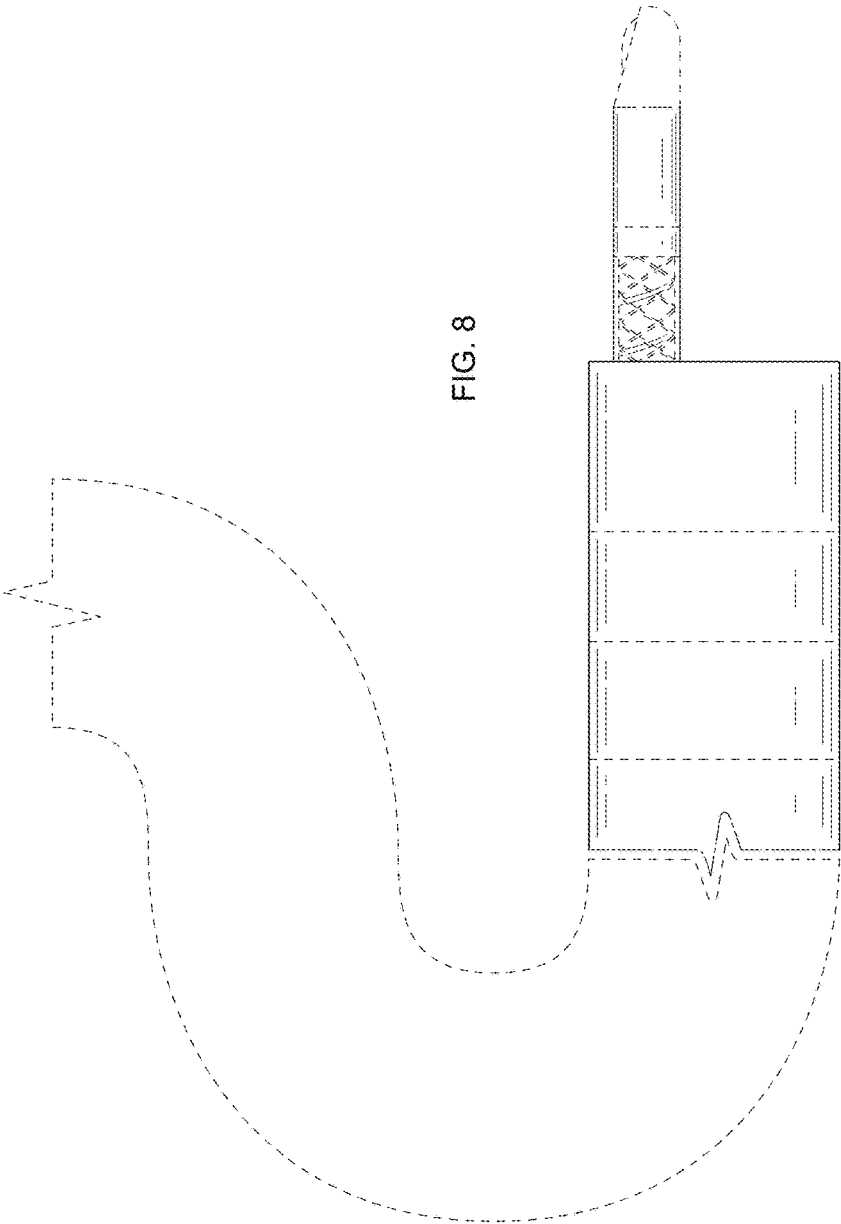

FIG. 8